



DRIVE-THRU SYSTEM

Our Drive-thru System features multiple options for drive-thru canopies, speaker covers and clearance bars. These products offer easy access, informative signage, and lighted coverage so that your patrons are protected from the elements. Our canopies come with LED light options and are ready to accept fans and heaters.



DRIVE-THRU CANOPY SERIES 100

- Maximum overhang projection - 7' 0"
- 14.5" Face
- Ask about sizing options

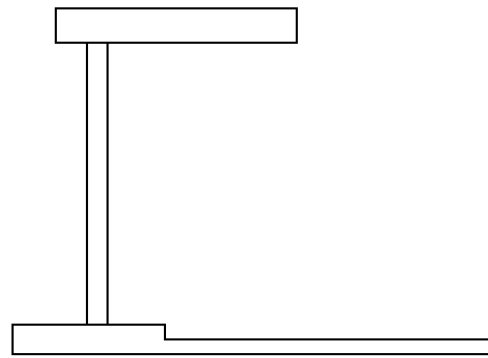
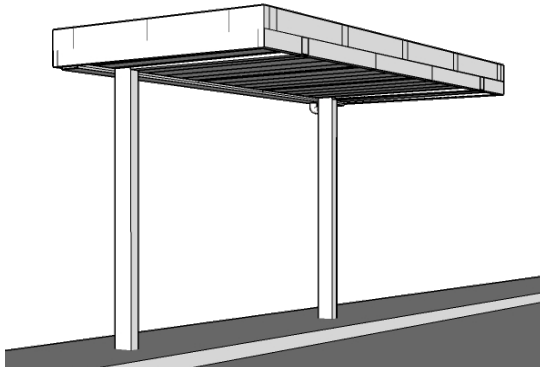

ELEVATION VIEW

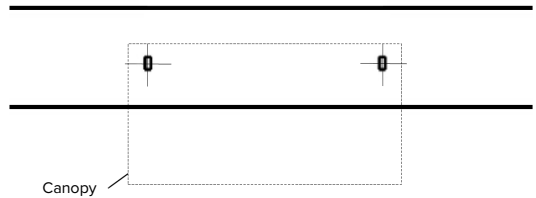

PLAN VIEW

DRIVE-THRU CANOPY SERIES 200

- Maximum overhang projection - 7' 0"
- 18.5" Face
- Ask about sizing options

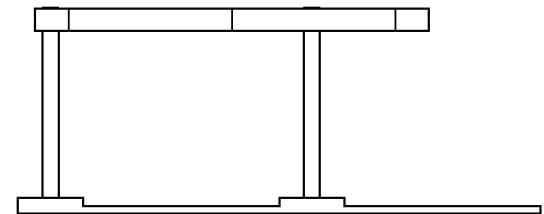
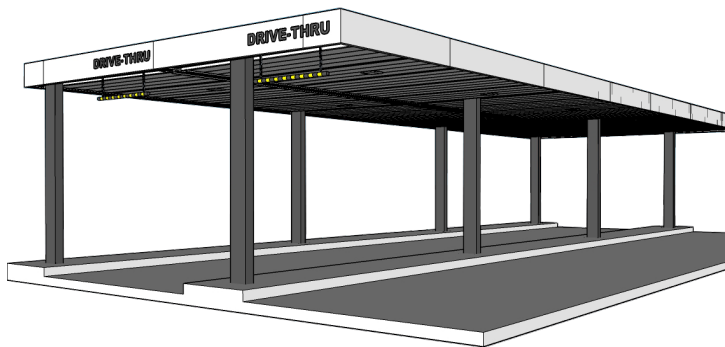

ELEVATION VIEW

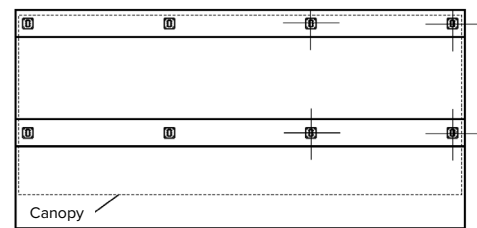

PLAN VIEW

OPTIONS

- Face details, integrated lighting, graphics
- Electrical accessories such as switches, outlets
- Soffit lights and water management
- Hook-ups for fans and heaters (fans and heaters not provided by AwneX)

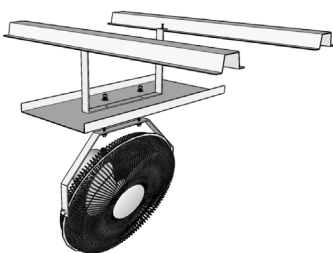

FAN INSTALL

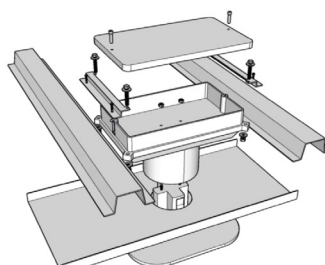

SOFFIT LIGHT INSTALL

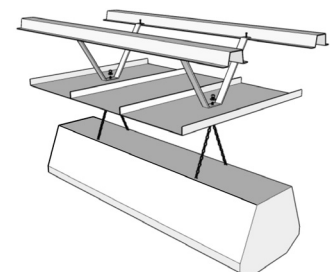

HEATER INSTALL

GUARDIAN SPEAKER COVER

STANDARD SPECIFICATIONS

- Post: 5" square steel. Black - Standard - Other colors are available
- Canopy: 100% aluminum construction and will rotate upon impact
- Frame: tubing and plate 6063-T6
- Top cladding: .063" aluminum sheet 3003 series aluminum

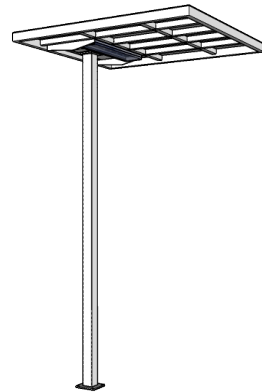

LIGHTING OPTIONS

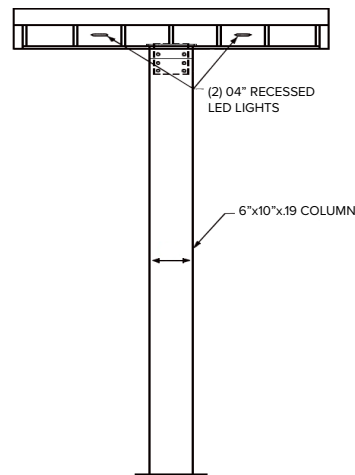
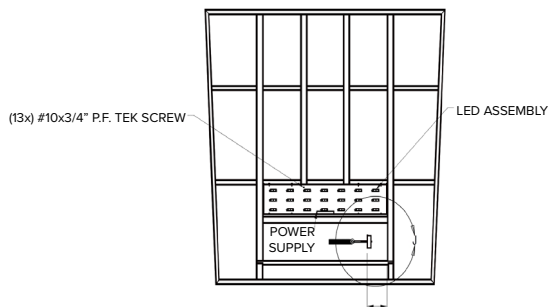

CLEARANCE BARS

STANDARD SPECIFICATIONS

- Steel post with aluminum arm bar
- Powder coated finish
- Graphic options
- Various heights available
- Fixed or pivoted options

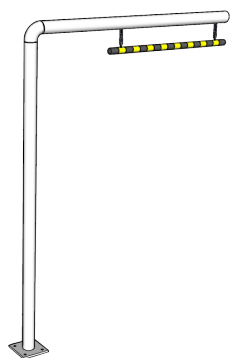

FIXED CLEARANCE BAR
OPTION 1

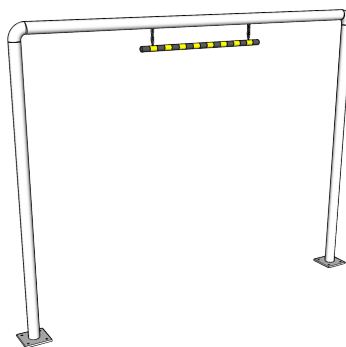

FIXED CLEARANCE BAR
OPTION 2

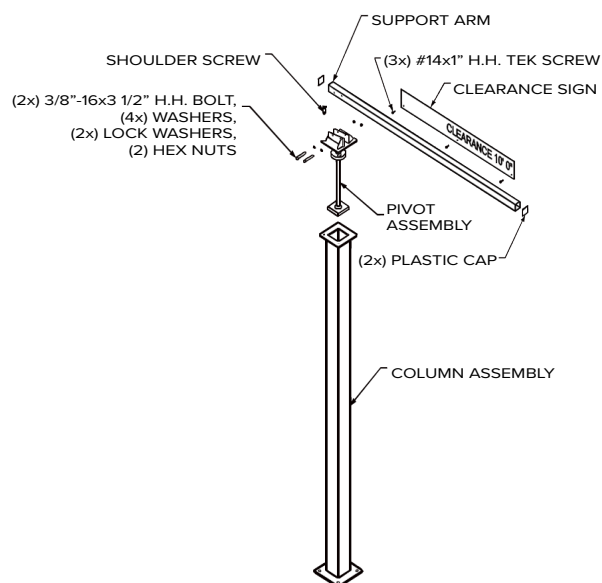

PIVOTED CLEARANCE BAR