

SEATTLE CANOPY SYSTEM

Seattle canopies are a unique system with innovative flexibility to provide rain and sun protection. These canopies can be built with a front gutter and scuppers, or with back gutter and downspouts to drain water. This powder coated, all-aluminum constructed canopy is easily installed and can be field fitted if necessary. Seattle canopies are also available with different face options and integrated LED lighting for visual and functional effects.



CANOPY SIZES

- Projections: From 2' up to 6'
- Single Frame Width max:
 - Up to 4' projection is 16' length
 - At 5' projection is 12' length
 - At 6' projection is 10' length
- Multiple Frame Runs: Up to 32' max length of run
- System not designed for corner frames or building notches

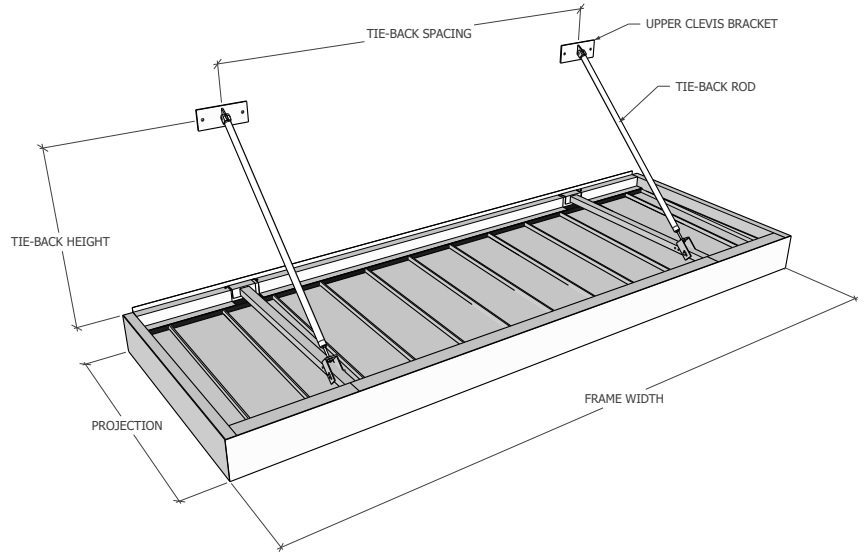

CUSTOM SIZES

Projections that are greater than 5' are account specific designs and will require additional engineering. *These projections fall outside our standard pricing models.*

TIE-BACK OPTIONS

- Spacing: 88" Max
- Height: Flexible
- Rod size: 1 1/4" DIA (1 1/2" for high wind & snow load)
- Brackets: 4" x 8"

CROSS SECTION

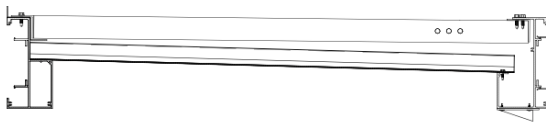

FRONT GUTTER WITH SCUPPER

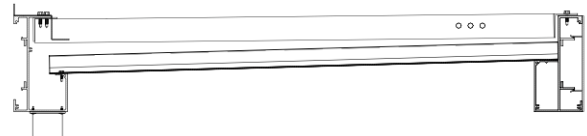

REAR GUTTER WITH OUTLET

FACE OPTIONS

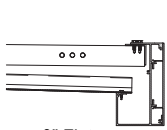

8" Flat (Standard)

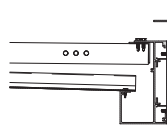

10" Flat

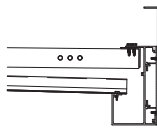

12" Flat

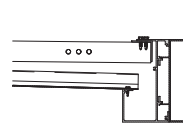

8" Open

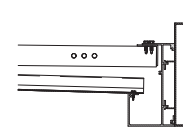

10" Open

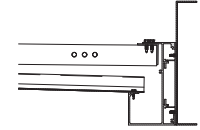

12" Open

BLOCKING EXAMPLES

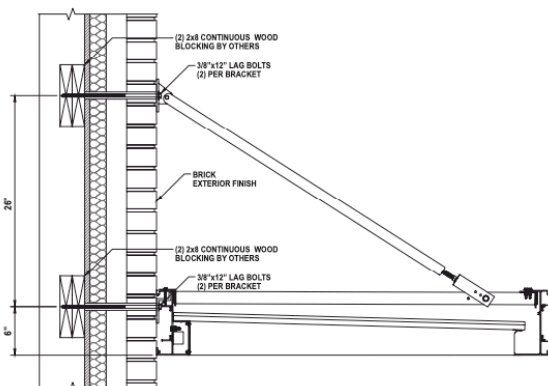

BRICK WITH INSULATION OVER WOOD BLOCKING

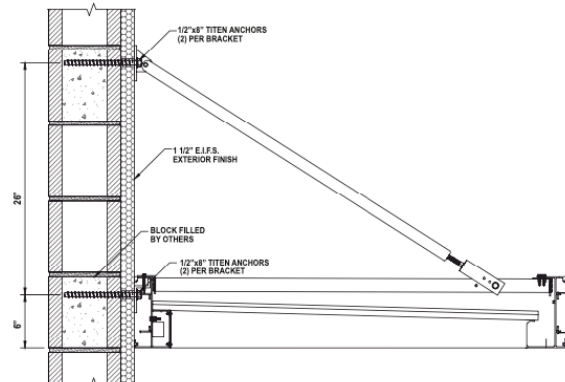

E.F.I.S OVER CMU BLOCK WALL

WATER MANAGEMENT

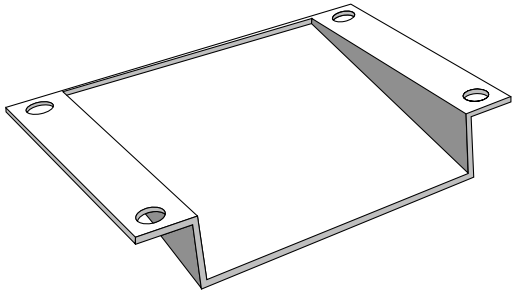

SCUPPER

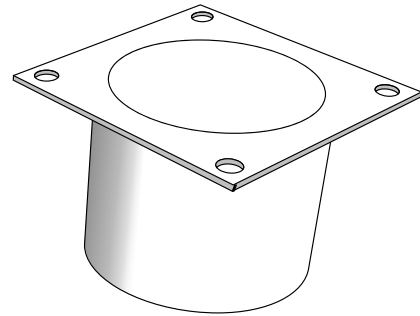

OUTLET

LED LIGHTING

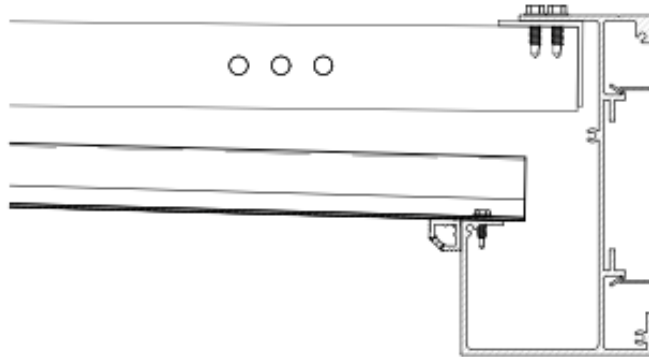

WITH LED STRIP LIGHT

CANTILEVERED OPTION

STEEL TUBE OUTRIGGERS

- Minimum face height must be 12"
- Maximum spacing is 70"
- Maximum projection of 4'-0"

